

Article number: 09066622

Description: KLEE Feather keys B 6x6x22 DIN 6885

Measures

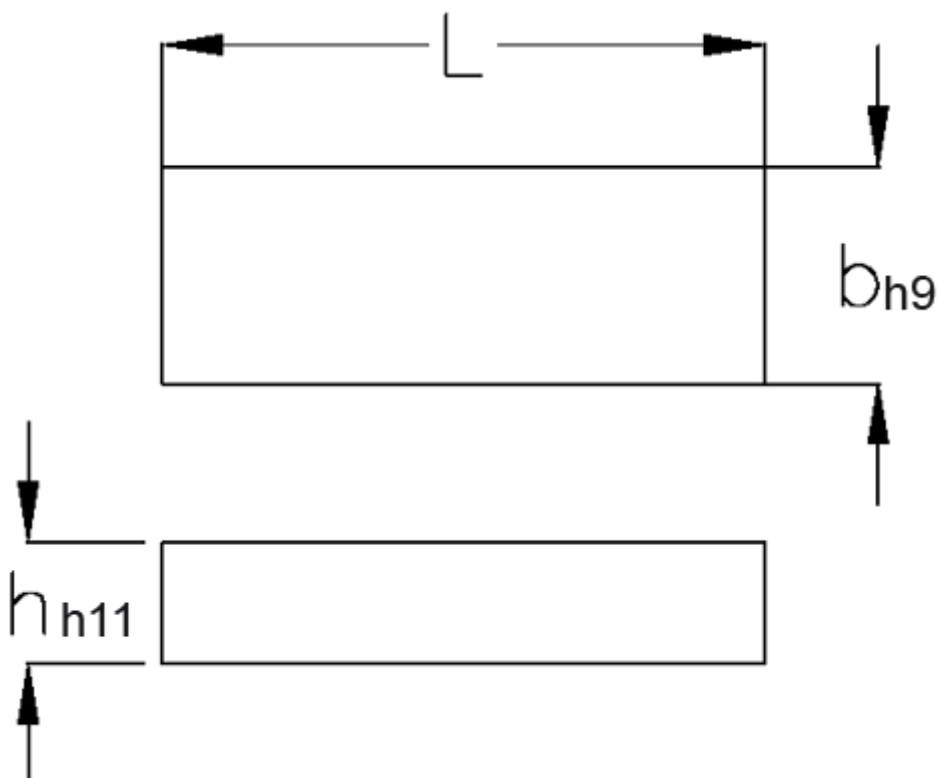

b	$= 6$
h	$= 6$
L	$= 22$
Tolerance b	$= 0.030$
Tolerance h	$= 0.075$
Tolerance L	$= -0,3$